

Surface Mount Transient Voltage Suppressor

Uni-directional

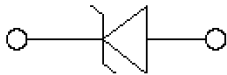
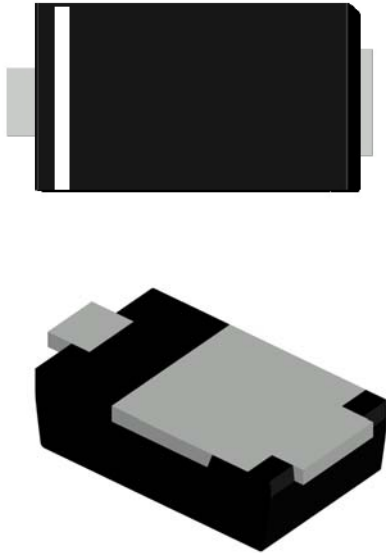

Features

- For surface mounted applications
- Low-profile package
- Ideal for automated placement
- Available in Unidirectional and Bidirectional
- 400 W peak pulse power capability with a 10/1000 μ s waveform
- Low incremental surge resistance, excellent clamping capability
- Very fast response time
- High temperature soldering guaranteed: 260 °C/10 s at terminals
- Meets MSL level 1
- Component in accordance to RoHS

Typical Applications

Use in sensitive electronics protection against voltage transients induced by inductive load switching and lighting on ICs, MOSFET, signal lines of sensor units for consumer, computer, industrial, telecommunication.

Mechanical Date

- **Package:** SOD-123HE
Molding compound meets UL 94 V-0 flammability rating, RoHS-compliant, halogen-free
- **Terminals:** Tin plated leads, solderable per J-STD-002 and JESD22-B102
- **Polarity:** For uni-directional types the band denotes cathode end

■Maximum Ratings ($T_a=25^\circ\text{C}$ Unless otherwise specified)

PARAMETER	SYMBOL	UNIT	Conditions	Max
Peak power dissipation ⁽¹⁾ ⁽²⁾ (Fig.1)	P_{PPM}	W	with a 10/1000us waveform	400
Peak pulse current ⁽¹⁾	I_{PPM}	A	with a 10/1000us waveform	(See Next Table)
Power dissipation, on infinite heat sink	P_D	W	$T_L=75^\circ\text{C}$	0.4
Peak forward surge current, 8.3 ms single half sine-wave unidirectional only ⁽³⁾	I_{FSM}	A		20
Maximum instantaneous forward voltage	VF	V	IF=1A	1.5
Operating junction temperature range	T_J	$^\circ\text{C}$		-55 to +150
Storage temperature range	T_{STG}	$^\circ\text{C}$		-55 to +150
Electrostatic Discharge	ESD	KV	IEC61000-4-2 air discharge	± 30
Electrostatic Discharge			IEC61000-4-2 contact discharge	
Thermal resistance ⁽³⁾	$R_{\theta JL}$	$^\circ\text{C/W}$	Between junction and lead	35
	$R_{\theta JA}$		Between junction and Ambient	200



SM4FE SERIES

Notes:

- (1). Non repetitive current pulse, per Fig2 and derated above TA=25°C per Fig3.
- (2). Measured on 8.3 ms single half sine-wave or equivalent square wave, duty cycle = 4 pulses per minute maximum
- (3). Thermal resistance from junction to ambient and from junction to lead mounted on P.C.B. with 0.2" x 0.2" (5.0 mm x 5.0 mm) copper pad areas

Ordering Information (Example)

PREFERED P/N	PACKING CODE	UNIT WEIGHT(g)	MINIMUM PACKAGE(pcs)	INNER BOX QUANTITY(pcs)	OUTER CARTON QUANTITY(pcs)	DELIVERY MODE
SM4FE SERIES	F1	0.024	3000	24000	96000	7" reel

Electrical Characteristics (TA=25°C unless otherwise noted)

Part Number	Marking	Breakdown Voltage $V_{BR}@I_T$			Maximum Reverse Leakage $I_R^{(3)}$ @ V_{RWM} (μA)	Working Peak Reverse Voltage V_{RWM} (V)	Maximum Reverse Surge Current $I_{PP}^{(2)}$ (A)	Maximum Clamping Voltage V_C @ I_{PP} (V)
		Min(V)	Max (V)	$I_T^{(1)}$ (mA)				
SM4FE5.0A	E5.0A	6.4	7.07	10	800	5	43.38	9.2
SM4FE6.0A	E6.0A	6.67	7.37	10	800	6	38.83	10.3
SM4FE6.5A	E6.5A	7.22	7.98	10	500	6.5	35.71	11.2
SM4FE7.0A	E7.0A	7.78	8.6	10	200	7	33.33	12
SM4FE7.5A	E7.5A	8.33	9.21	1	100	7.5	31.01	12.9
SM4FE8.0A	E8.0A	8.89	9.83	1	50	8	29.41	13.6
SM4FE8.5A	E8.5A	9.44	10.4	1	10	8.5	27.78	14.4
SM4FE9.0A	E9.0A	10	11.1	1	5	9	25.97	15.4
SM4FE10A	E10A	11.1	12.3	1	2.5	10	23.52	17
SM4FE11A	E11A	12.2	13.5	1	2.5	11	21.98	18.2
SM4FE12A	E12A	13.3	14.7	1	2.5	12	20.1	19.9
SM4FE13A	E13A	14.4	15.9	1	1	13	18.6	20
SM4FE14A	E14A	15.6	17.2	1	1	14	17.24	23.2
SM4FE15A	E15A	16.7	18.5	1	1	15	16.4	24.4
SM4FE16A	E16A	17.8	19.7	1	1	16	15.38	26
SM4FE17A	E17A	18.9	20.9	1	1	17	14.5	27.6
SM4FE18A	E18A	20	22.1	1	1	18	13.7	29.2
SM4FE19A	E19A	21.1	23.3	1	1	19	13.08	30.6
SM4FE20A	E20A	22.2	24.5	1	1	20	12.34	32.4
SM4FE22A	E22A	24.4	26.9	1	1	22	11.26	35.5
SM4FE24A	E24A	26.7	29.5	1	1	24	10.28	38.9
SM4FE26A	E26A	28.9	31.9	1	1	26	9.5	42.1
SM4FE28A	E28A	31.1	34.4	1	1	28	8.82	45.4
SM4FE30A	E30A	33.3	36.8	1	1	30	8.26	48.4
SM4FE33A	E33A	36.7	40.6	1	1	33	7.5	53.3
SM4FE36A	E36A	40	44.2	1	1	36	6.88	58.1
SM4FE40A	E40A	44.4	49.1	1	1	40	6.2	64.5
SM4FE43A	E43A	47.8	52.8	1	1	43	5.76	69.4
SM4FE45A	E45A	50	55.3	1	1	45	5.5	72.7
SM4FE48A	E48A	53.3	58.9	1	1	48	5.16	77.4
SM4FE51A	E51A	56.7	62.7	1	1	51	4.86	82.4
SM4FE54A	E54A	60	66.3	1	1	54	4.6	87.1
SM4FE58A	E58A	64.4	71.2	1	1	58	4.28	93.6
SM4FE60A	E60A	66.7	73.7	1	1	60	4.14	96.8



SM4FE SERIES

SM4FE64A	E64A	71.1	78.6	1	1	64	3.88	103
SM4FE70A	E70A	77.8	86	1	1	70	3.54	113
SM4FE75A	E75A	83.3	92.1	1	1	75	3.3	121
SM4FE78A	E78A	86.7	95.8	1	1	78	3.18	126
SM4FE80A	E80A	88.8	97.6	1	1	80	3.1	129
SM4FE85A	E85A	94.4	104	1	1	85	2.92	137
SM4FE90A	E90A	100	111	1	1	90	2.74	146
SM4FE100A	E100A	111	123	1	1	100	2.46	162

Notes:

- (1) $t_p \leq 50\text{ms}$ Pulse test: $t_p \leq 50\text{ms}$.
- (2) Surge current waveform per Fig. 2 and derated per Fig.3.
- (3) For bi-directional types having V_{RWM} of 10 V and less, the I_R limit is doubled.

■ Characteristics(Typical)

FIG1: Peak Pulse Power Rating Curve

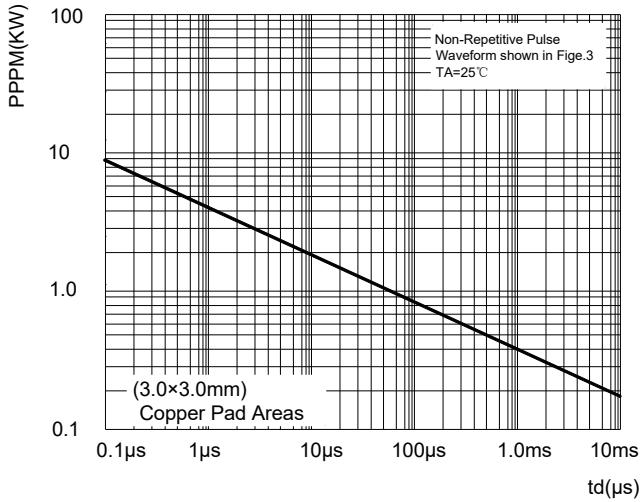

FIG2: Pulse Waveform

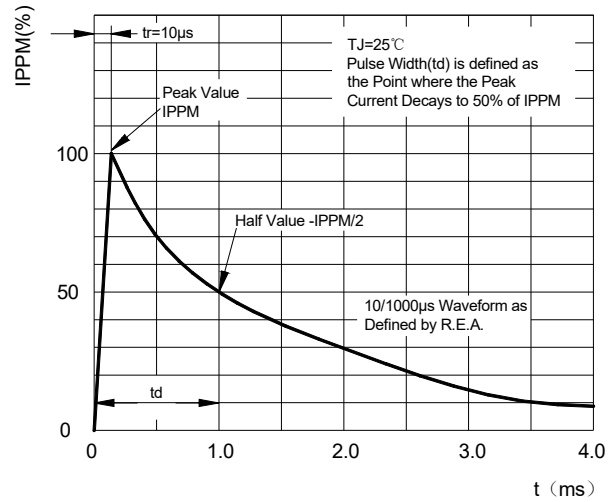

FIG3: Pulse Power or Current vs. Initial Junction Temperature

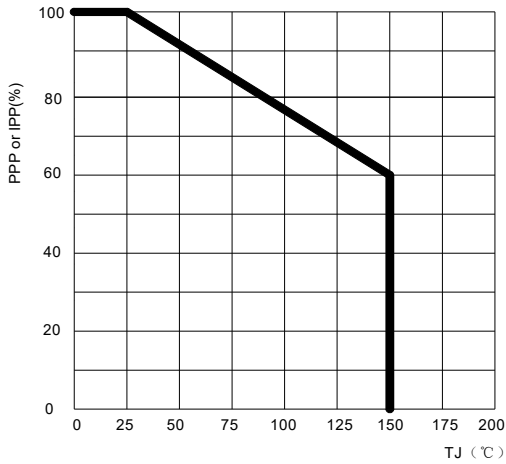
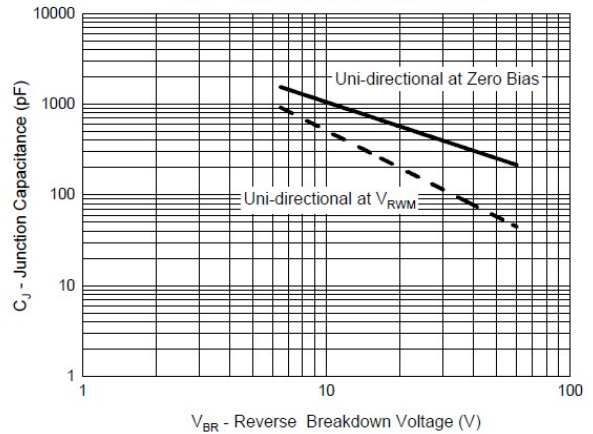

Fig.4 - Typical Junction Capacitance





SM4FE SERIES

■ Outline Dimensions

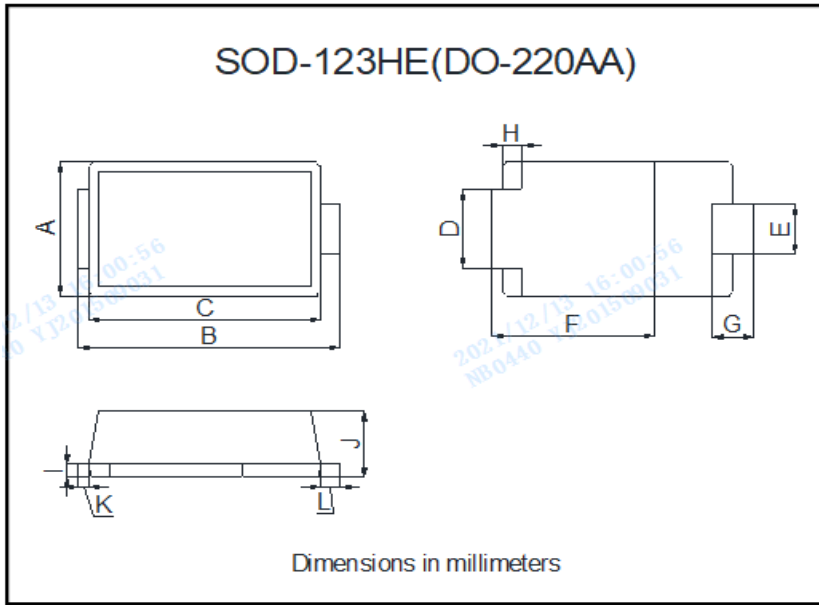

SOD-123HE(DO-220AA)		
Dim	Min	Max
A	1.88	2.18
B	3.70	4.00
C	3.19	3.61
D	1.05	1.35
E	0.61	0.91
F	2.20	2.60
G	0.40	0.80
H	0.30 REF	
I	0.10	0.30
J	0.85	1.15
K	0.00	0.30
L	0.15	0.45

■ Suggested pad layout

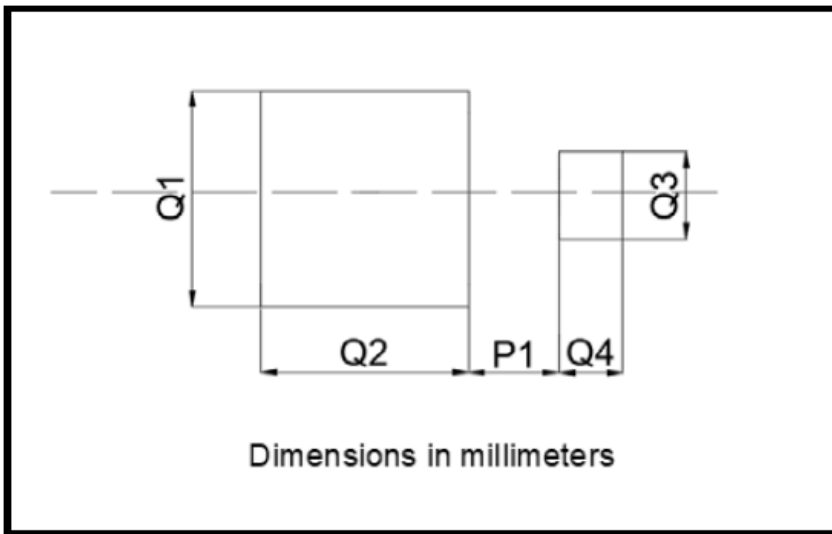

Dim	Millimeters
P1	0.64
Q1	2.54
Q2	2.67
Q3	1.27
Q4	0.76



SM4FE SERIES

Disclaimer

The information presented in this document is for reference only. Yangzhou Yangjie Electronic Technology Co., Ltd. reserves the right to make changes without notice for the specification of the products displayed herein to improve reliability, function or design or otherwise.

The product listed herein is designed to be used with ordinary electronic equipment or devices, and not designed to be used with equipment or devices which require high level of reliability and the malfunction of which would directly endanger human life (such as medical instruments, transportation equipment, aerospace machinery, nuclear-reactor controllers, fuel controllers and other safety devices), Yangjie or anyone on its behalf, assumes no responsibility or liability for any damages resulting from such improper use of sale.

This publication supersedes & replaces all information previously supplied. For additional information, please visit our website [http:// www.21yangjie.com](http://www.21yangjie.com) , or consult your nearest Yangjie's sales office for further assistance.